

Kaleido-Solo

High-Quality Video and Loudness Monitoring with 3G/HD/SD SDI to HDMI Conversion



Cost-efficient performance and versatility.

Kaleido-Solo is a compact, standalone 3G/HD/SD SDI video to HDMI converter that enables the use of low-cost LCD displays for video and loudness/dialnorm monitoring.

Ideal for many professional monitoring applications, including production, mobile truck, post-production and broadcast, Kaleido-Solo eliminates the cost and complexity of a traditional loudness monitoring device.

KEY FEATURES

- 3G/HD/SD to HDMI converter for video and audio monitoring
- Offers high quality and rich monitoring using a low-cost LCD panel
- Dual program loudness and dialnorm monitoring over time (KS-910 only)
 - Enhanced loudness measurements
 - EBU R128
 - ATSC A/85 ITU BS.1770-1
 - ATSC A/85 ITU BS.1770-2
 - ATSC A/85 ITU BS.1770-3
 - ARIB TR-B32
 - Full-screen layout
 - Loudness configurable alarm threshold
 - Offline capture automation (EOM/SOM)
 - Optional logging capabilities via iControl or iControl Solo
 - Measure from internal down mix processing
- Automatic input format detection
- Supports 525i, 625i, 720p, 1080i and 1080p video resolutions
- Multiple frame rate support including 23.98p/PsF, 24p/PsF, 25p/PsF, 50i, 50p, 59.94i and 59.94p
- Built-in scaler/deinterlacer
- Optical SFP fiber input/output options
- S/PDIF digital audio terminal that can output either:
 - A 5.1 downmix
 - Any PCM stereo pair
- Analog audio terminal that can output either:
 - A 5.1 downmix
 - Any PCM stereo pair
- Selectable burn-in and metadata overlay
 - History graph of audio loudness levels and dialnorm
 - ALM (audio level, phase and peak meters)
 - Can display from Dolby-E (KS-910 only)
 - Can display from internal down mix (KS-910 only)
 - Timecode
 - AFD/WSS/VLI
 - Customizable names
 - Aspect ratio markers
 - Dynamic UMD (under monitor display) and tallies
 - Subtitling (608, Legacy 608, 708, Teletext, OP-47)
 - V-Chip/CAD
- Menu navigation through web browser
- Monitor power saving mode
- Configurable presets
- Configurable general purpose input/output (GPIO)
- Automatic aspect ratio support
- Video scaling and positioning options
- HDMI 5.1 audio support
- Easy configuration using on-screen menus
- Failsafe mechanism for unsupported monitor resolutions
- Convenient mounting bracket included
- Optional remote control for menu navigation and configurable buttons

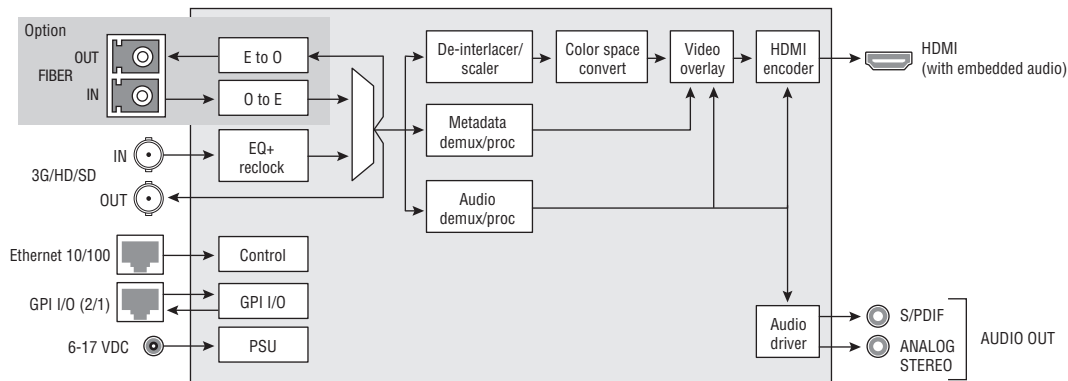

Kaleido-Solo functional block diagram

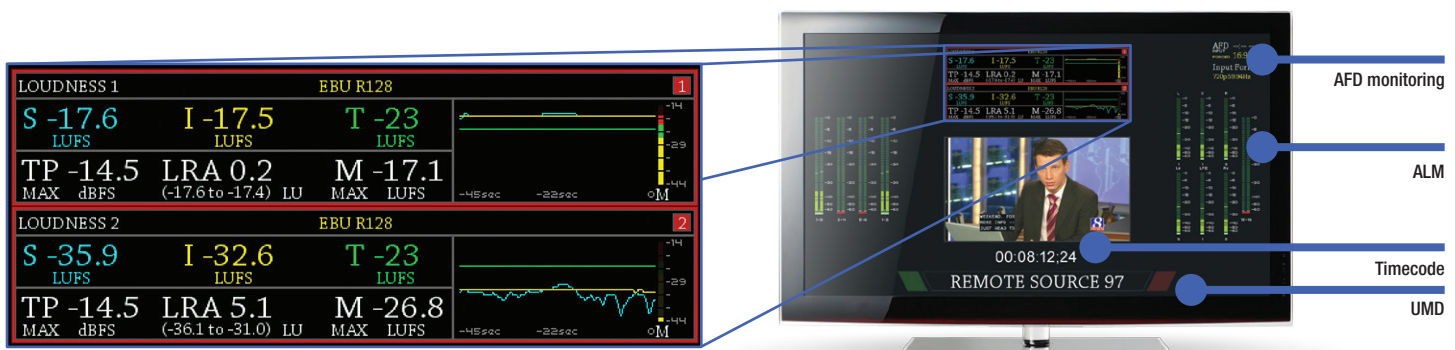

History graph with loudness and dialnorm

Broadcast Application: Loudness Monitoring In Master Control

Kaleido-Solo can be used to monitor the video and loudness level at the output of a master control switcher.

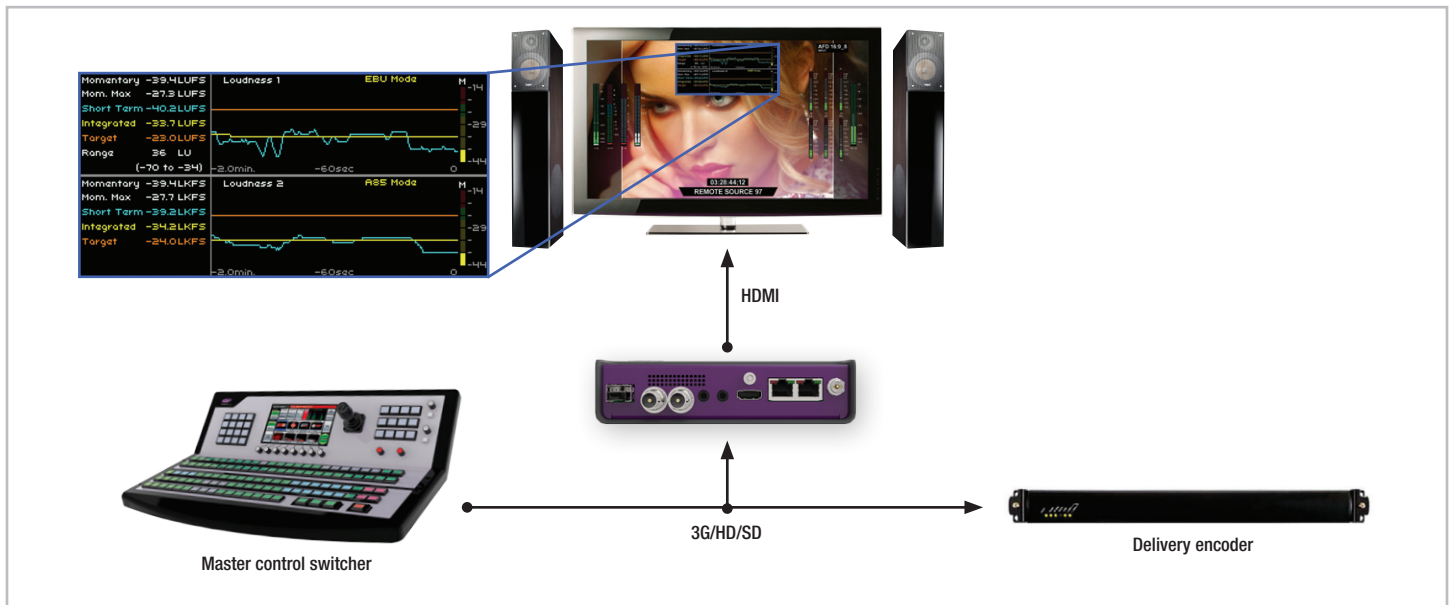

Broadcast Application: Incoming/Outgoing Feed Monitoring

Monitoring the incoming feeds, or the feeds going on-air, including the AFD, loudness, and dialnorm metadata.

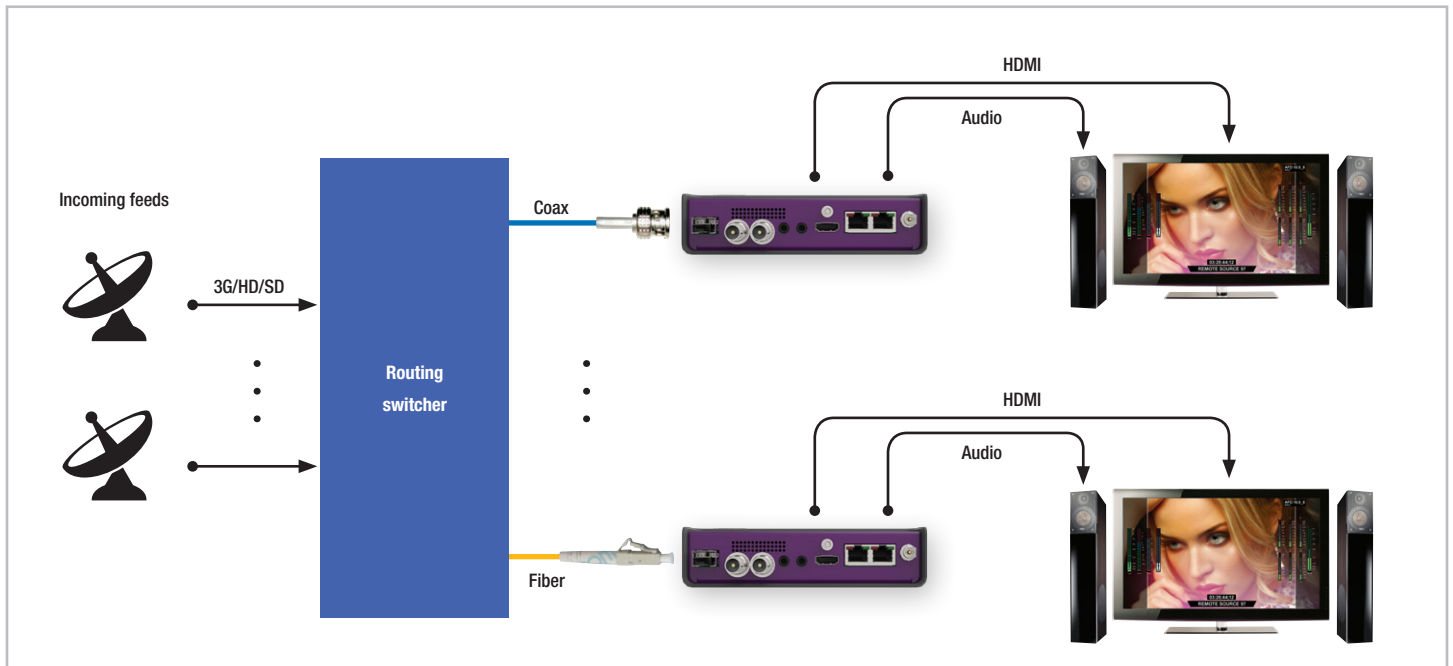

Production Application: On-Set Monitoring

Kaleido-Solo is used to feed a low-cost display with HDMI input for full 3G/HD monitoring, with all essential on-screen-display information.

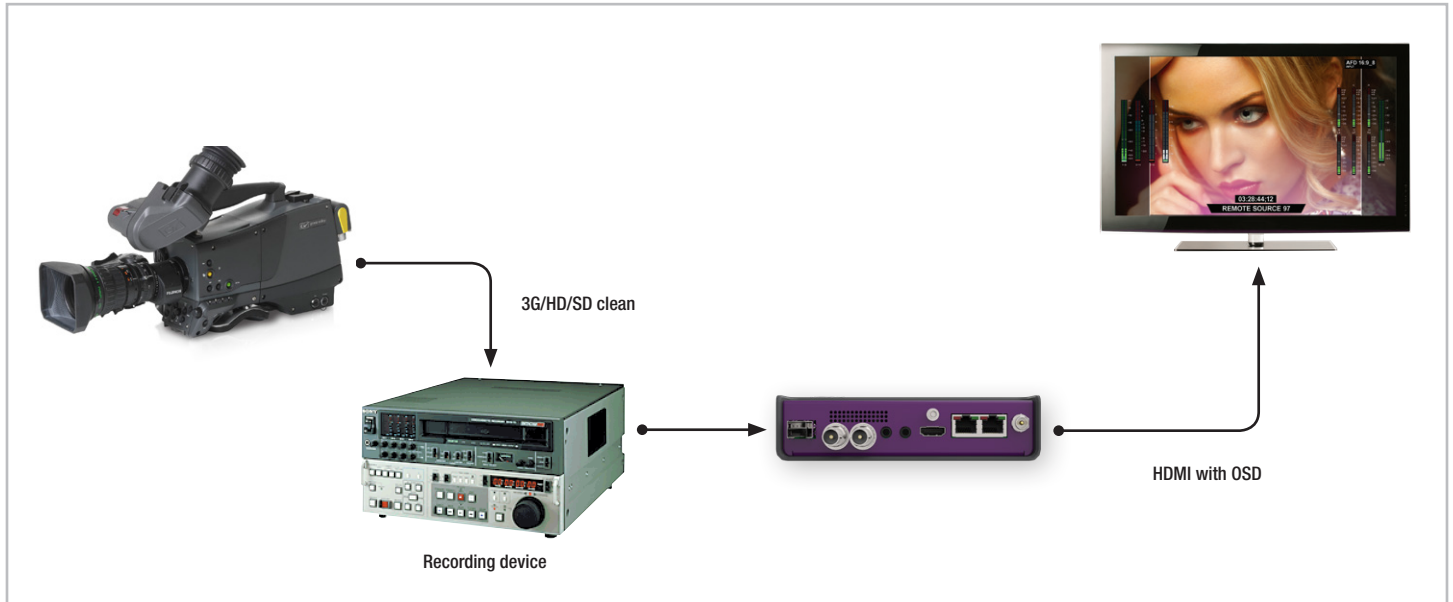

Post-Production Application: Editing Suite Monitoring

Kaleido-Solo is used for client monitoring in the editing suite, and for video confidence monitoring during dubs in the machine room. This solution supports 3G, HD and SD, and thereby removes the need for a setup change when switching back and forth between HD and SD sessions.

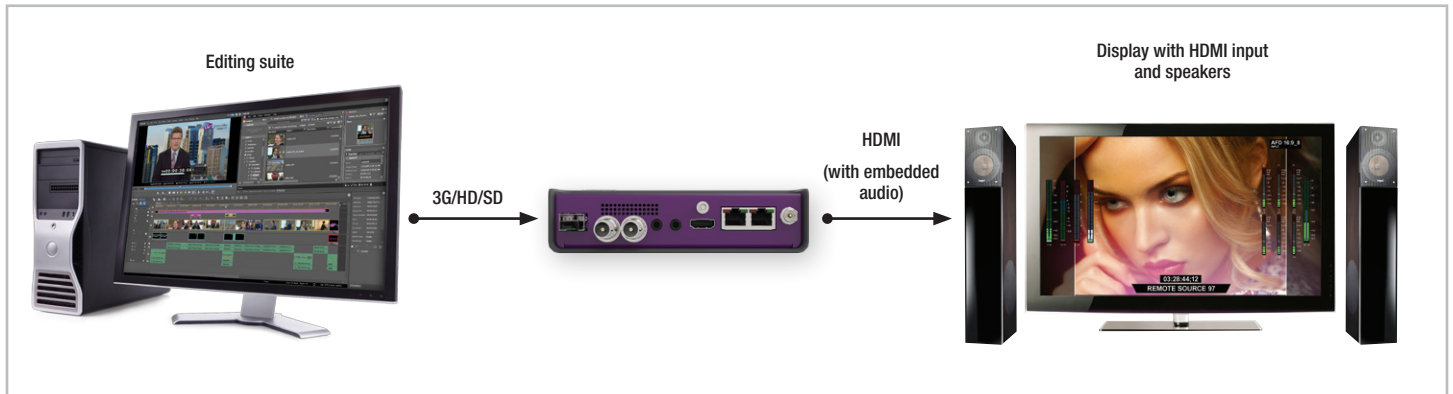

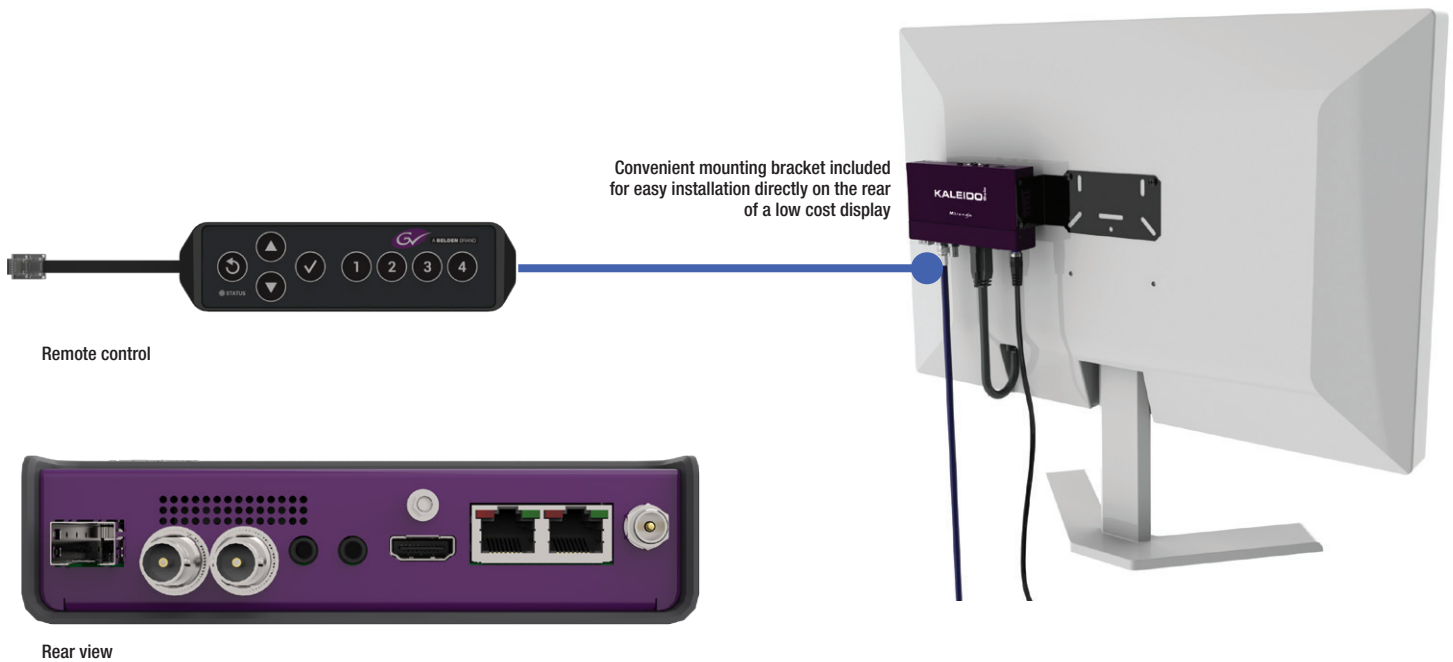

SPECIFICATIONS

Video Input

Signal:

- SMPTE ST 259-C (270 Mb/s)
- SMPTE ST 272-C (270 Mb/s with embedded audio)
- SMPTE ST 292, SMPTE ST 299 (HD: 1.485, 1.485/1.001 Gb/s)
- SMPTE ST 425 (2.970, 2.970/1.001 Gb/s)

Supported formats:

- SD: 480i59.94, 576i50
- HD: SMPTE ST 274: 1080i50/59.94, 1080p/59.94
- HD: SMPTE ST 296: 720p50/59.94
- 3G: SMPTE ST 425 level A (mapping 1): 1080p50/59.94

Cable length:

- 240m (787 ft.) Belden 1694A at 270 Mb/s
- 150m (492 ft.) Belden 1694A at 1.485 Gb/s
- 120m (393 ft.) Belden 1694A at 2.97 Gb/s

Return loss:

- >15 dB up to 1.5 GHz
- >10 dB up to 3 GHz

Jitter:

- HD/SD: <0.2 UI as per alignment jitter in SMPTE spec.
- 3G: <0.3 UI as per alignment jitter in SMPTE spec.

Fiber I/O

SMPTE ST 297-2006 compliant
 Single receive or transmit or receive/transmit SFP module: Dual receive or transmit modules can be installed, but only one Rx or Tx channel will be used
 For full specifications on SFP optical modules, please see www.grassvalley.com

HDMI Output

- Connector: HDMI Type A
- Standard: HDMI 1.3a
- Format: Compliant to EIA/CEA-861-D

Analog Audio Output

- Connector: 3.5 mm (0.138 in.) stereo jack
- Signal: 2 channels unbalanced analog audio
- Level: 2 Vp-p
- Impedance: 10 kΩ

S/PDIF

- Connector: 3.5 mm (0.138 in.) stereo jack
- Signal: IEC 60958
- Level: 0.5 Vp-p ±20%
- Impedance: 75Ω unbalanced
- Sampling rate: 48 kHz

Ethernet

- Connector: RJ45

Processing

- Signal path: 8 bits
- Processing delay: 1 frame

Electrical

- Voltage range: 6 to 17 VDC
- Power: 10W



ORDERING

Product	Description
KS-900	3G/HD/SD to HDMI converter with audio
KS-910	3G/HD/SD to HDMI converter with audio and loudness meter
KS-Remote	Kaleido-Solo remote control

Options (hardware)

SFP-R-LC	Single fiber Rx (input) cartridge with LC/PC connector
SFP-RT-S13-LC	Dual fiber Rx/Tx (input/output) cartridge 1310 nm with LC/PC connector
SFP-T-S13-LC	Single fiber Tx (output) cartridge at 1310 nm with LC/PC connector

Other types of SFP Optical Plug-In Cartridges may be available for this product



GVB-1-0229B-EN-DS

WWW.GRASSVALLEY.COM

Join the Conversation at [GrassValleyLive](#) on Facebook, Twitter, YouTube and [Grass Valley - A Belden Brand](#) on LinkedIn.



Belden, Belden Sending All The Right Signals and the Belden logo are trademarks or registered trademarks of Belden Inc. or its affiliated companies in the United States and other jurisdictions. Grass Valley, iControl and Kaleido are trademarks or registered trademarks of Grass Valley, Belden Inc., Grass Valley and other parties may also have trademark rights in other terms used herein.

Copyright © 2014, 2016 Grass Valley Canada. All rights reserved. Specifications subject to change without notice.